

Exterior Lighting

exl

1

REVISION
APR 2005

TABLE OF CONTENTS

Standards of Excellence	2
Exeter® (7322/7320/7324).....	3
Bridgewater® (7334/7332)	4
Bridgewater® (7331/7330)	5
Cumberland® (7342/7343)	6
Cumberland® (7345/7346)	7
Cumberland® (7364)	8

Exterior Lighting

STANDARDS OF EXCELLENCE

Solid brass construction for durability.

The Lifetime Finish™ from Baldwin® provides an impenetrable barrier coating that protects the polished brass forever. Guaranteed not to pit or tarnish for the life of the product.

112 Venetian Bronze and 150 Satin Nickel are lacquer finishes over 100% pure premium brass. Both finishes meet the rigorous standards for material, durability, and visual specs for alternative finishes. Like all lacquer finishes, breakdown will occur over time.

Baldwin is renowned for meeting the stringent demands for quality and authenticity in the restoration-retrofit-rehabilitation markets. Our designers work closely with a number of America's most prestigious museums and historical foundations for design inspiration.

Completely stainless steel concealed fasteners to enhance appearance, with porcelain sockets and metal socket covers to increase lantern lifetime.

Styling compatible with other exterior products to complete the Lifetime Entrance story.

Numerous patents, copyrights, and trademarks are held by the Corporation to protect the integrity and reputation of our distinctive line of hardware and decorative appointments.

All exterior lighting products are cULus Listed. Wall and Post Mount Lanterns are cULus listed for wet locations.

INSTALLATION INSTRUCTIONS

All exterior lighting is shipped with installation instructions in the carton, the proper mounting hardware, and socket covers where appropriate.

Read all instructions and review diagrams before beginning with the installation of the fixture. Before installing the light fixture, refer to the section titled Electrical Connections. IF THE CONSUMER FEELS HE/SHE DOES NOT HAVE ELECTRICAL WIRING EXPERIENCE, refer him/her to a do-it-yourself wiring handbook or suggest the fixture be installed by a qualified licensed electrician.

All electrical connections must be in accordance with local codes, ordinances or the National Electrical Code. **If you are unfamiliar with methods of electrical wiring, secure the services of a qualified licensed electrician.** HINT: Position wire nuts in upright position to prevent water from pooling.

These fixtures are intended to be mounted to a 4" metal octagon electrical box. The electrical box must be attached to and directly supported by the building structure.

Before starting the installation, disconnect the power by turning off the circuit breaker or removing the fuse at the fuse box.

For complete mounting directions, refer to Outdoor Wall Mounted Lantern Instructions (PK7320, PK7342), Post Mounted Lantern Instructions (PK7326T), or Pedestal Mount instructions (PK 7364).

Exterior Lighting

exl

3

REVISION
APR 2005

EXETER®

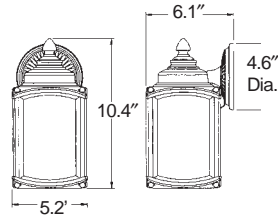

7322.003

Exeter Lantern

Specifications

Length: 10-³/₈" (264mm)
 Width: 5-¹/₄" (133mm)
 Projection: 6-¹/₁₆" (154mm)
 Bulb Type: Standard Edison Base/100 watt
 Lighting Configuration: single bulb
 Finish: 003 Lifetime Finish
 Shipping Weight: 5.25 lbs.

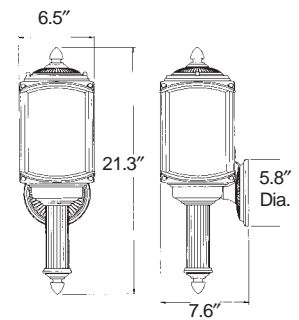

7324.003

Exeter Lantern

Specifications

Length: 21-¹/₈" (537mm)
 Width: 6-¹/₂" (165mm)
 Projection: 7-¹/₂" (191mm)
 Bulb Type: Standard Edison Base/100 watt
 Lighting Configuration: single bulb
 Finish: 003 Lifetime Finish
 Shipping Weight: 9.9 lbs.

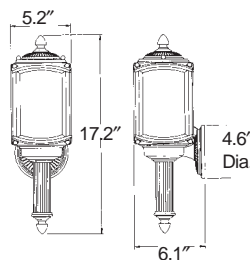

7320.003

Exeter Lantern

Specifications

Length: 17-¹/₈" (435mm)
 Width: 5-¹/₄" (133mm)
 Projection: 6-¹/₁₆" (154mm)
 Bulb Type: Standard Edison Base/100 watt
 Lighting Configuration: single bulb
 Finish: 003 Lifetime Finish
 Shipping Weight: 5.85 lbs.

 WET LOCATION

Exterior Lighting

BRIDGEWATER®

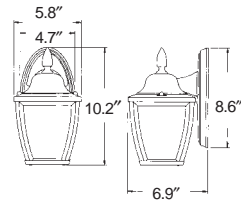

7334.003

Bridgewater Lantern

Specifications

Length: 10-1/8" (257mm)
 Width: 6" (152mm)
 Projection: 5-3/4" (146mm)
 Bulb Type: Standard Edison Base/100 watt
 Lighting Configuration: single bulb
 Finish: 003 Lifetime Finish
 Shipping Weight: 5.2 lbs.

Also Available: 112 Venetian Bronze™ Finish
 150 Satin Nickel Finish

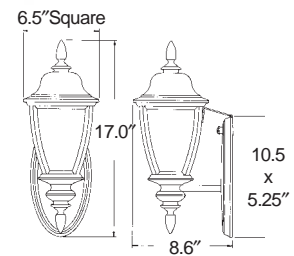

7332.003

Bridgewater Lantern

Specifications

Length: 16-3/4" (426mm)
 Width: 6-3/4" (172mm)
 Projection: 8-5/8" (219mm)
 Bulb Type: Standard Edison Base/100 watt
 Lighting Configuration: single bulb
 Finish: 003 Lifetime Finish
 Shipping Weight: 9.1 lbs.

Also Available: 112 Venetian Bronze™ Finish
 150 Satin Nickel Finish



Exterior Lighting

exl

5

REVISION
APR 2005

BRIDGEWATER®

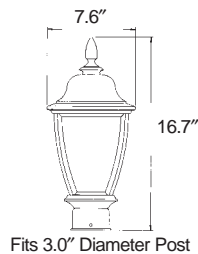

7331.003

Bridgewater Post Lantern

Specifications

Length:	16-11/16"	(424mm)
Width:	7-5/8"	(194mm)
Projection:	none	
Bulb Type:	Standard Edison Base/100 watt	
Lighting Configuration:	single bulb	
Finish:	003 Lifetime Finish	
Shipping Weight:	8.35 lbs.	

Also Available: 112 Venetian Bronze™ Finish
150 Satin Nickel Finish

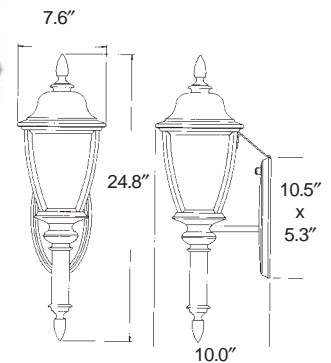

7330.003.T

Bridgewater Lantern - w/Tail

Specifications

Length:	24-15/16"	(633mm)
Width:	7-5/8"	(194mm)
Projection:	9-15/16"	(252mm)
Bulb Type:	Standard Edison Base/100 watt	
Lighting Configuration:	single bulb	
Finish:	003 Lifetime Finish	
Shipping Weight:	11.90 lbs.	

Also Available: 112 Venetian Bronze™ Finish
150 Satin Nickel Finish

 WET LOCATION

Exterior Lighting

CUMBERLAND®

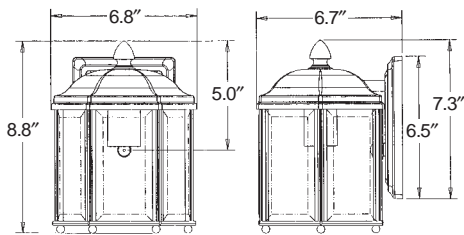

7342.003

Garage Light Lantern

Specifications

Length: 8-13/16" (224mm)
 Width: 6-3/4" (172mm)
 Projection: 6-11/16" (170mm)
 Bulb Type: Standard Edison Base/60 watt
 Lighting Configuration: single bulb
 Finish: 003 Lifetime Finish
 Shipping Weight: 6.15 lbs.

Also Available: 112 Venetian Bronze™ Finish
 150 Satin Nickel Finish

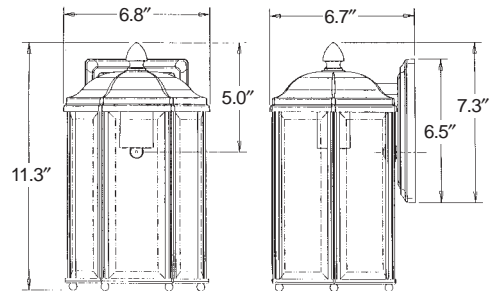

7343.003

Porch Light Lantern

Specifications

Length: 11-5/16" (287mm)
 Width: 6-3/4" (172mm)
 Projection: 6-11/16" (170mm)
 Bulb Type: Standard Edison Base/60 watt
 Lighting Configuration: single bulb
 Finish: 003 Lifetime Finish
 Shipping Weight: 6.9 lbs.

Also Available: 112 Venetian Bronze™ Finish
 150 Satin Nickel Finish



Exterior Lighting

exl

7

REVISION
APR 2005

CUMBERLAND®

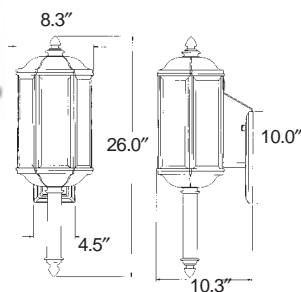

7345.003.T

Specifications

Length:	26"	(660mm)
Width:	7-3/8"	(187mm)
Projection:	10-1/4"	(260mm)
Bulb Type:	Candelabra Base – Type B/60 watts	
Lighting Configuration:	3-candle	
Finish:	003 Lifetime Finish	
Shipping Weight:	13.65 lbs.	

Also Available: 112 Venetian Bronze™ Finish
150 Satin Nickel Finish

Cumberland Lantern w/Tail

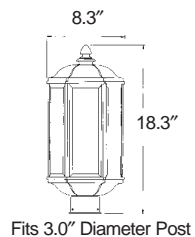

7346.003

Specifications

Length:	18-1/8"	(460mm)
Width:	7-3/8"	(187mm)
Projection:	none	
Bulb Type:	Candelabra Base – Type B/60 watts	
Lighting Configuration:	3-candle	
Finish:	003 Lifetime Finish	
Shipping Weight:	11.05 lbs.	

Also Available: 112 Venetian Bronze™ Finish
150 Satin Nickel Finish

Cumberland Post Lantern

 WET LOCATION

Exterior Lighting



7364.003

Pier Mount Base

Specifications

Diameter:	7"	(178mm)
Mount Opening:	3"	(76mm)
Shipping Weight:	1.55 lbs.	

**Available: 003 Lifetime Polished Brass Finish
112 Venetian Bronze™ Finish
150 Satin Nickel Finish**